

# Acesight



## User Guide

V 1.2

**CONTENTS**

- 1. What’s in the box ..... 4
  - 1.1 Device Accessories ..... 4
  - 1.2 Acesight Headset..... 5
  - 1.3 Controller ..... 6
- 2. Getting Started..... 7
  - 2.1 Preparing to use Acesight..... 7
    - 2.1.1 Charge the Device ..... 7
    - 2.1.2 Turn the Device On/Off..... 8
  - 2.2 Put on the Headset..... 8
    - 2.2.1 Adjust the Rim ..... 8
    - 2.2.2 Adjust the Interpupillary Distance ..... 10
- 3. Basic Functions..... 13

---

|   |    |
|---|----|
| 3.1 Turn On/Off .....   | 13 |
| 3.2 Zoom In/Out .....   | 13 |
| 3.3 Focus Lock .....  | 14 |
| 3.4 Color Mode.....   | 15 |
| 3.4.1 Regular Color Mode .....  | 15 |
| 3.4.2 Favorite Color Mode .....   | 16 |
| 3.5 Outline .....   | 18 |
| 3.6 Adjust Thickness of Outlines/Contrast of High Contrast Colors ..... | 19 |
| 3.7 Narrow Display .....  | 19 |
| 3.7.1 Enter Narrow Display .....  | 19 |
| 3.7.2 Change the Display Position.....                                  | 20 |
| 3.7.3 Viewing in Narrow Display .....                                   | 21 |
| 3.8 Swift Restoration .....   | 22 |
| 3.9 Brightness Adjustment .....   | 23 |
| 4. Advanced Functions .....   | 24 |
| 4.1 Floating Reading Mode.....  | 24 |

- 4.1.1 Enter Preview ..... 25
- 4.1.2 Enter/Exit Floating Reading Mode ..... 25
- 4.2 Lock/Unlock the Controller ..... 27
- 4.3 Find Function ..... 28
- 5. Menu ..... 29
  - 5.1 Calibration ..... 30
  - 5.2 Narrow Mode ..... 30
  - 5.3 Visual Styles ..... 31
  - 5.4 Refresh Rate ..... 32
  - 5.5 Version ..... 33
- 6. Notes on Use ..... 34

# 1. WHAT'S IN THE BOX

## 1.1 DEVICE ACCESSORIES

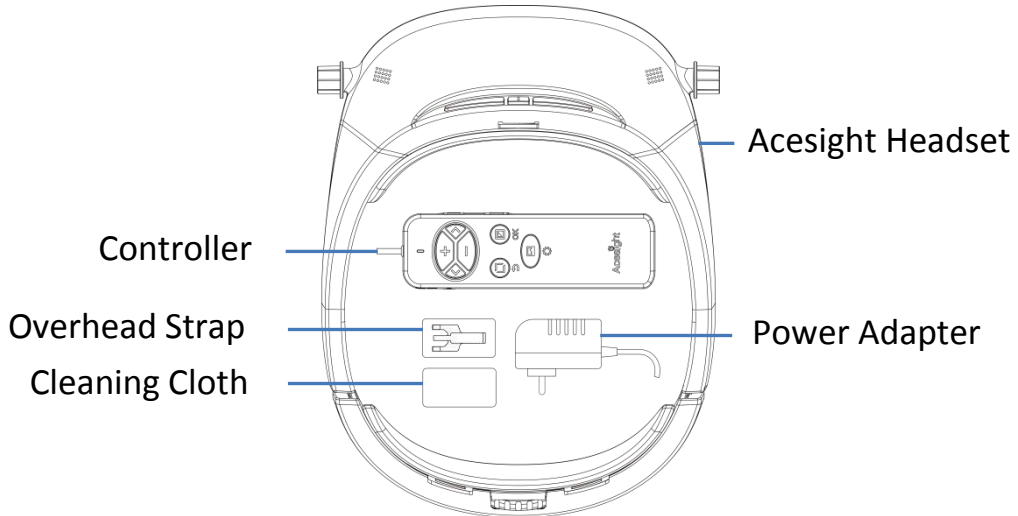

## 1.2 ACESIGHT HEADSET

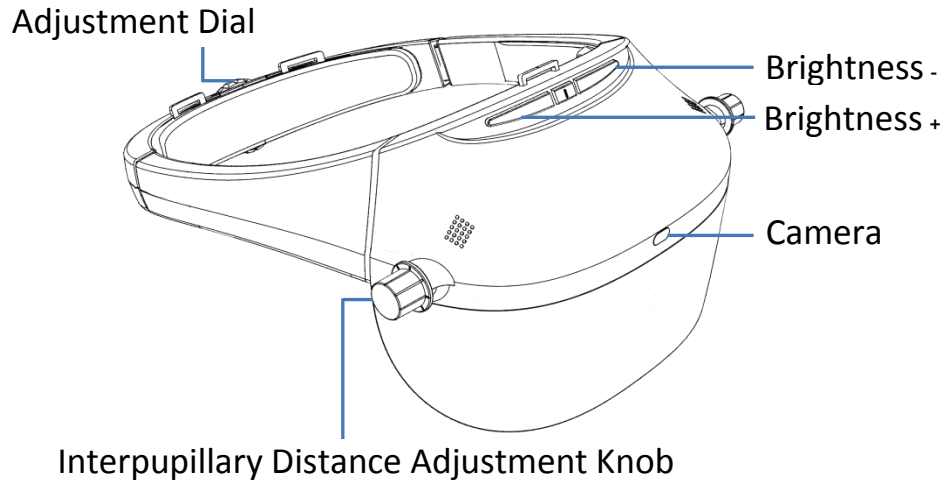

1.3 CONTROLLER

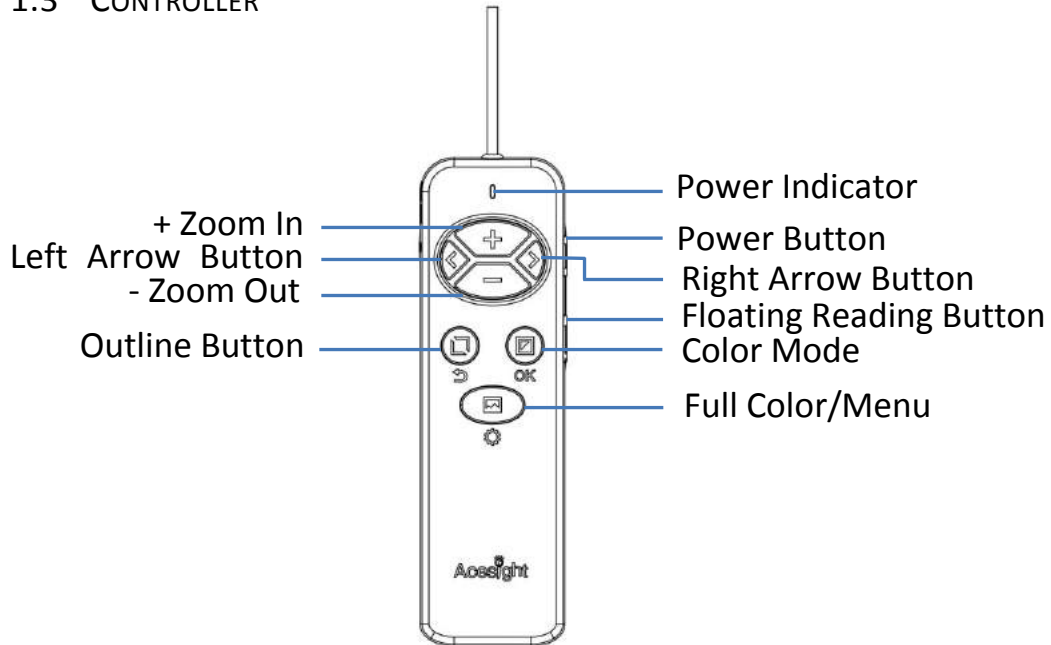

## 2. GETTING STARTED

### 2.1 PREPARING TO USE ACESIGHT

#### 2.1.1 CHARGE THE DEVICE

When connected to the power adapter, the Power Indicator is blue. It will flash slowly when the device is charging and change to a solid light when charging is complete.

When the Power Indicator flashes green fast and the battery icon on the Acesight screen turns to , the battery level is low. Please charge the device.



Short press the Power Button to check the current battery level.

### 2.1.2 TURN THE DEVICE ON/OFF

Press the Power Button for 2 seconds to turn the Acesight on. You can turn the device off in the same way. When the device is on, the indicator will turn green.

## 2.2 PUT ON THE HEADSET

### 2.2.1 ADJUST THE RIM

Step 1: Turn the Adjustment Dial at the back of the Acesight headset counterclockwise to loosen the headset rim.

Step 2: Put on the headset, making sure that your eyes are directly behind the lenses. The device should be centered. Turn the Dial clockwise after the headset is in the good place for a snug fit.

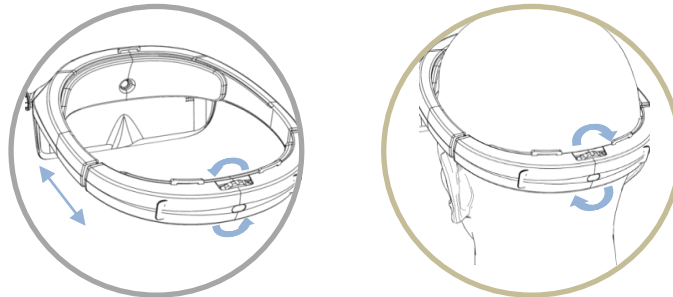

### 2.2.2 ADJUST THE INTERPUPILLARY DISTANCE

Interpupillary Distance Adjustment function will be automatically on when the Acesight is turned on the first time. A yellow on black pattern will be shown as below. By pressing the Arrow Buttons “◀” and “▶”, you can switch the high contrast color between default setting and white on black.



Close a single eye to look at the image. Turn the Interpupillary Distance Knob on the same side with the open eye to ensure a clear display if the image is vague. Do the same with the other eye. Press the Color Mode Button “” on the controller to enter the main view.

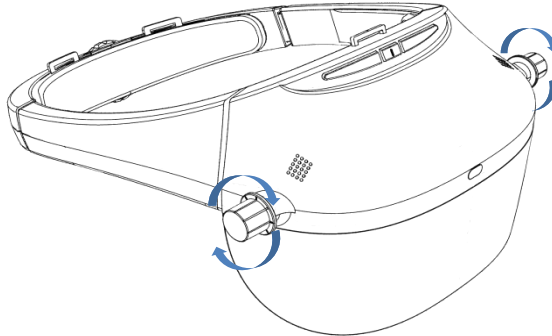

**Note:** For a more comfortable fit, insert the ends of the overhead strap through the loops on the Acesight headset. Fasten the Velcro tabs to ensure a suitable position.

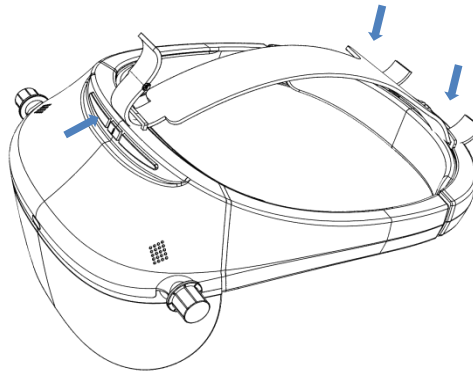

### 3. BASIC FUNCTIONS

#### 3.1 TURN ON/OFF

Press Power Button “

#### 3.2 ZOOM IN/OUT

Press Zoom In Button “+” and Zoom Out Button “-” to zoom the view in and out. To turn the image to the lowest magnification quickly, press Zoom Out Button “-” for 2 seconds. To turn the image to the highest magnification quickly, press Zoom In Button “+” for 2 seconds.

The magnification range of Acesight is 1.1x to 15x.

### 3.3 FOCUS LOCK

In general, the camera of Acesight is auto-focus. However, if a specific focus is needed, you can activate the Focus Lock to turn auto-focus off by pressing the Arrow Buttons “◀” and “▶” simultaneously to fix the current focus. Go back to auto-focus in the same way.

The following display will show on the screen when Focus Lock is on/off.



### 3.4 COLOR MODE

#### 3.4.1 REGULAR COLOR MODE

Press the Color Mode Button “” to change color modes among full color and 10 high contrast colors as below:

|                        |                        |
|------------------------|------------------------|
| <b>Black on White</b>  | <b>White on Black</b>  |
| <b>Blue on White</b>   | <b>White on Blue</b>   |
| <b>Black on Yellow</b> | <b>Yellow on Black</b> |
| <b>Yellow on Blue</b>  | <b>Blue on Yellow</b>  |
| <b>Black on Green</b>  | <b>Green on Black</b>  |





### 3.4.2 FAVORITE COLOR MODE

Press Color Mode Button “” for 2 seconds to activate Favorite Color Mode. The image will turn to the following pattern before entering the Favorite Color Mode:





In Favorite Color Mode, only three color modes are available: full color, the last high contrast color selected before you entered the Favorite Color Mode, and its reverse mode.

Entering Favorite Color Mode in full color will make the high contrast color black on white or white on black.

Press the Color Mode Button “A 3x3 grid of colored squares. The top row contains yellow, red, and pink squares. The middle row contains light green, light grey, and purple squares. The bottom row contains dark green, cyan, and dark blue squares.

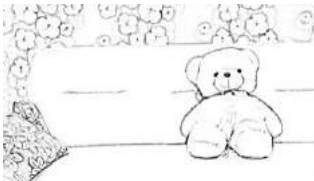
### 3.5 OUTLINE

Press Outline Function Button “A black and white image showing a teddy bear sitting on a couch. The entire scene is rendered in white lines on a black background, representing the 'Black on White' outline display.

Black on White

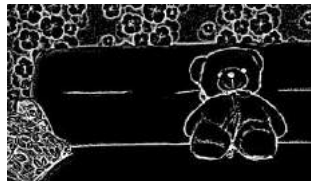

White on Black



Black Outline on Full Color

To remove outlines, short press Full Color/Menu Button “

18

### 3.6 ADJUST THICKNESS OF OUTLINES/CONTRAST OF HIGH CONTRAST COLORS

The thickness of the outline in Outline Function and the range of the contrast in high contrast color are adjustable in 5 levels by pressing Arrow Buttons “◀” and “▶” to adapt to various eye conditions and environments.





### 3.7 NARROW DISPLAY



#### 3.7.1 ENTER NARROW DISPLAY

Before entering the Narrow Display, the Narrow Mode must be on. Please refer to Narrow Mode section on page 31 for more information.

When the Narrow Mode is on, short press Zoom Out Button “-” in the lowest magnification in real-time view to enter Narrow Displays: 1/4 (25%) or 1/16 (6.25%) of the original size.

### 3.7.2 CHANGE THE DISPLAY POSITION

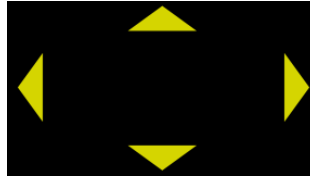
By default, the view is in the middle of the display. If that doesn't match your vision, press Outline Function Button “” for 3 seconds to move the view position. Use Zoom In Button “+”, Zoom Out Button “-”, and Arrow Buttons “” and “” to move the image up/down and left/right. Press Color Mode Button “” to save the new display, or Outline

Function Button “

### 3.7.3 VIEWING IN NARROW DISPLAY

In the Narrow Display, press color Mode Button “21

original size. Please note that 2-second press on Zoom In Button “+”/Zoom Out Button “-” to quickly go the lowest/highest magnification is unavailable in narrow display.

You can also show the image in various high contrast colors, and use the outline functions in the same way as not in the Narrow Display.

### 3.8 SWIFT RESTORATION

In real-time view, short press the Full Color/Menu Button “”, and the display will soon be restored to full color display despite all the image changes.

### 3.9 BRIGHTNESS ADJUSTMENT

Press the Brightness + and Brightness – buttons on the upper front of Acesight headset to adjust the display brightness.

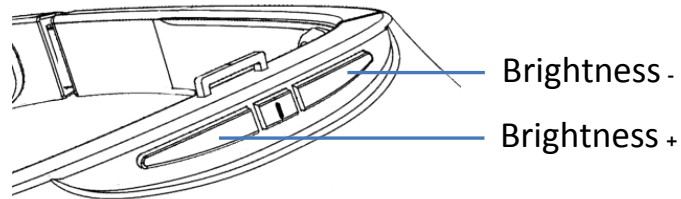





## 4. ADVANCED FUNCTIONS

### 4.1 FLOATING READING MODE

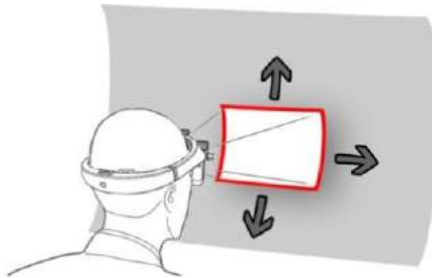
In Floating Reading Mode, the real-time view will be displayed as a large image. There will be a red frame around your view.



### 4.1.1 ENTER PREVIEW

In real-time view, short press the Floating Reading Mode Button “” to activate the floating preview.

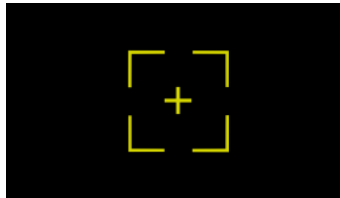

### 4.1.2 ENTER/EXIT FLOATING READING MODE

Press the Floating Reading Mode Button “” again to enter Floating Reading Mode.



Turn your head to look at different part of the image. It's available to zoom in/out, change color modes, outline the view, and adjust contrast and thickness range in Floating Reading Mode. Press Full Color/Menu Button “” to set the floating image back to the middle quickly.



Press Floating Reading Mode Button “” to exit Floating Reading Mode.

## 4.2 LOCK/UNLOCK THE CONTROLLER

In real-time view, by pressing Zoom In Button “+” and Zoom Out Button “-” simultaneously, the buttons on the controller will be locked until the next time Zoom In Button “+” and Zoom Out Button “-” are pressed simultaneously again.

When the controller is locked/unlocked, a big lock/unlock icon will appear in the middle of the screen. When the controller is locked, there will be a small lock icon in the upper left corner of the screen.

### 4.3 FIND FUNCTION

In real-time view, press Floating Reading Mode Button “” for 2 seconds. The Find Function will be activated and the red Find frame appears. Keep pressing and holding the Floating Reading Mode Button “”, and the image will be displayed at 1/5 (20%) of the current magnification.

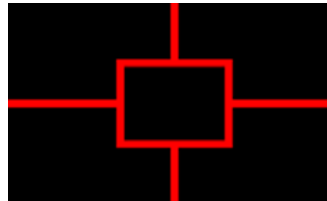

Turn your head and put the Find frame on the target, then release the button. The view will zoom in to its size in previous magnification as the Find frame disappears.

## 5. MENU

Press Full Color/Menu Button “

Press Color Mode Button “29



Calibration



Narrow Mode



Visual Styles



Refresh Rate



Version

## 5.1 CALIBRATION

This function enables you to adjust the interpupillary distance again. For detailed information, please refer to Adjust the Interpupillary Distance section on Page 10.

## 5.2 NARROW MODE

An activated Narrow Mode is a prerequisite to enter Narrow Displays (1/4 and 1/16). Please refer to Narrow Display section on Page 19 for detailed information.

To turn Narrow Mode on/off, enter Narrow Mode and use Arrow Buttons “◀” and “▶” to switch and choose with Color Mode Button “■”.

### 5.3 VISUAL STYLES

There are two visual styles installed: yellow on black and white on blue. Short press Arrow Buttons “◀” and “▶” to switch, and short press Color Mode Button “■” to select, or Outline Button “□” to exit.



## 5.4 REFRESH RATE

Refresh Rate enables you to adjust the Refresh Rate between 60 Hz and 50 Hz with Arrow Buttons “◀” and “▶” to adapt to viewing objects with different Refresh Rates. Short press Color Mode Button “■” to select, or Outline Button “□” to exit.



## 5.5 VERSION

Version shows the version information of software. Two other functions are included in Version: Factory Reset and Floating Reading Mode Calibration.

Please note that it's not suggested to use Floating Reading Mode Calibration Function without professional advice.



## 6. NOTES ON USE

Please be sure to read all of the following notes before attempting to use the Acesight:

- a) To avoid malfunctions and other damage, avoid using Acesight in the following locations.
- Places exposed to high temperature and/or high humidity, such as outside in the rain or near heating equipment
  - Locations subject to electromagnetic interference, such as next to medical devices that are unshielded.

- b) Do not attempt to repair Acesight or open its case to avoid voiding the warranty. Contact customer service if necessary.
- c) If Acesight becomes soiled, wipe it off using a soft, dry cloth. Use of organic solvents (such as thinner or benzene) causes deterioration and discoloration of the outer casing.

## **Zoomax Technology Co., Limited**

Add: 9F, Building D, Paradise Software Park, No.3 Xidoumen Rd,

Xihu District, Hangzhou, China 310012

Tel: +86 (0571) 8700-6308

Fax: +86 (0571) 8700-6292

Email: [support@acesight.com](mailto:support@acesight.com)

Visit us at [www.acesight.com](http://www.acesight.com)

